

KATALOG 2018



GRIPPER POL

KOMPONENTY DO BUDOWY CHWYTAKÓW

O Naszej Firmie



Głównym polem działania naszej firmy jest obsługa wtryskowni w dziedzinie urządzeń peryferyjnych takich jak:

- ▶ Systemy Centralnego Podawania Granulatu
- ▶ Stacje Obcinania Wlewka - Projektowanie i Budowa
 - ▶ Chwytaaki - Projektowanie i Budowa
 - ▶ Systemy Automatykacji Procesów
- ▶ Roboty Przemysłowe - Programowanie i Integracja



Zapraszamy na naszą stronę internetową
www.gripper-pol.pl



Spis Treści

1. *Elementy Konstrukcji*

1.1 Profile Konstrukcyjne

1.2 Zaślepki

1.3 Wsuwki

2. *Łączniki*

2.1 Łączniki Montażowe

2.2 Szybkozłącza

3. *Zaciski*

3.1 Zaciski Montażowe

3.2 Mocowania Ssawek

4. *Ssawki*

4.1 Ssawki próżniowe

4.2 Nypły

5. *Chwytaaki*

5.1 Równoległe

5.2 Kątowe

5.3 Palcowe

6. *Obcinaki*

7. *Siłowniki Pneumatyczne*

8. *Pozostałe*

8.1 Elementy Pneumatyki

8.2 Generatory Podciśnienia i Przewody

9. *Czujniki*

9.1 Czujniki Indukcyjne

9.2 Wtyczki do Czujników

10. *Akcesoria*

10.1 Kleje

10.2 Okładziny



1. Elementy Konstrukcji

1.1 Profile Konstrukcyjne

► Profile Aluminiowe

- Profile z wpustem o szerokości 6mm (wsuwka typu A)

GPA.1.1018

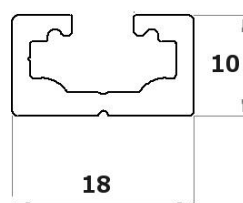

GPA.1.1818

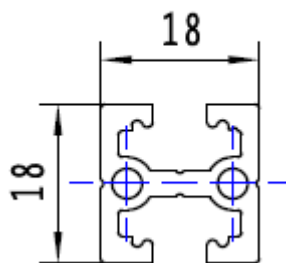

GPA.1.2525

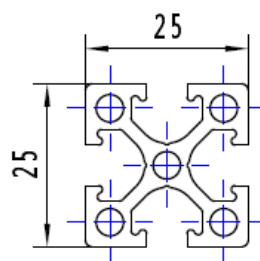

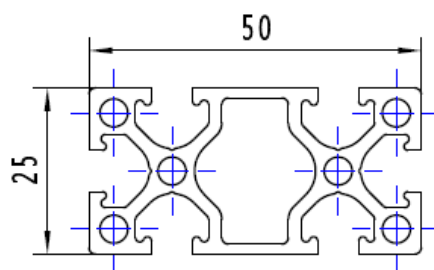
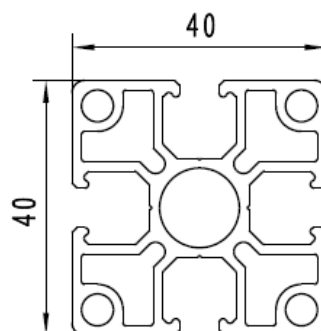
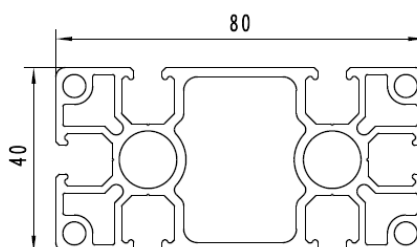
GPA.1.5025

GPA.1.4040

GPA.1.8040

| Oznaczenie handlowe | Waga [kg] |
|---------------------|-----------|
| GPA.1.1018 | 0,25 |
| GPA.1.1818 | 0,38 |
| GPA.1.2525 | 0,61 |
| GPA.1.4040 | 1,3 |
| GPA.1.5025 | 1,04 |
| GPA.1.8040 | 2,18 |

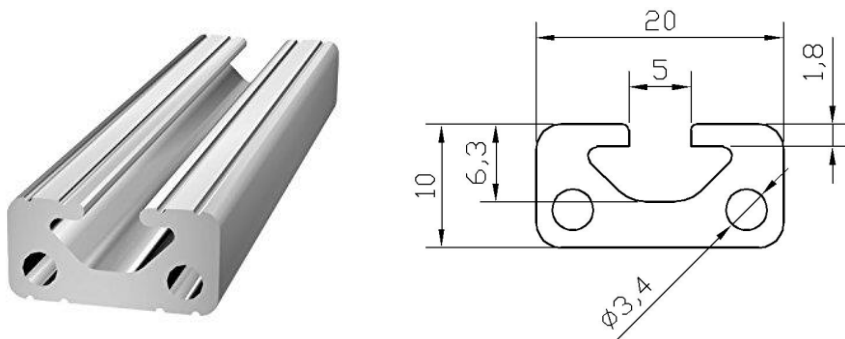
► Profile z wpustem o szerokości 5mm (wsuwka typu B)

GPB.1.1020



GPB.1.1040

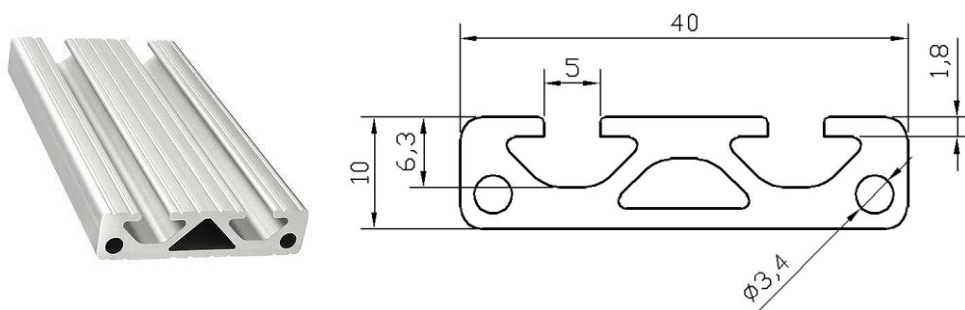

GPB.1.2020

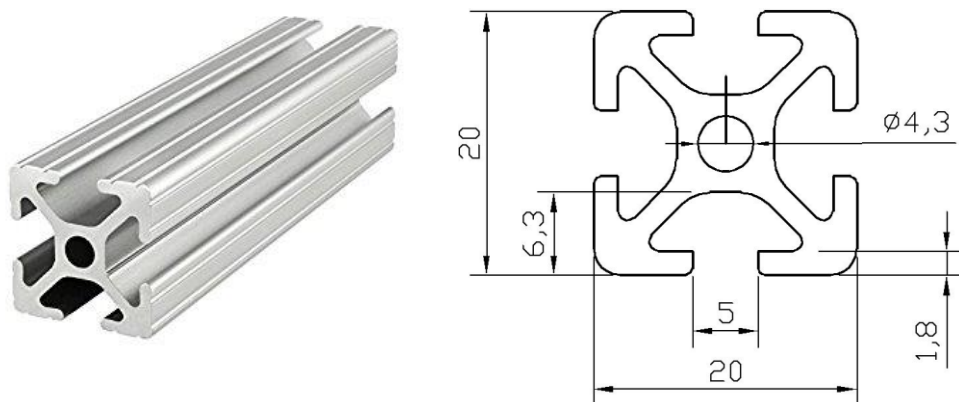

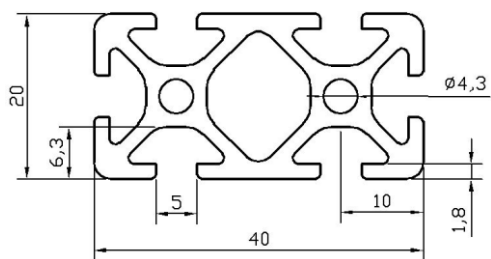
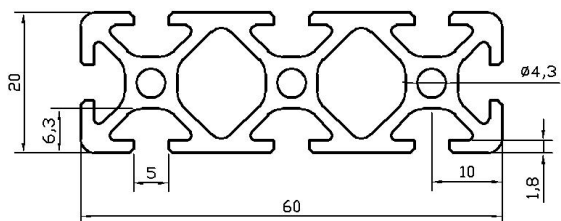
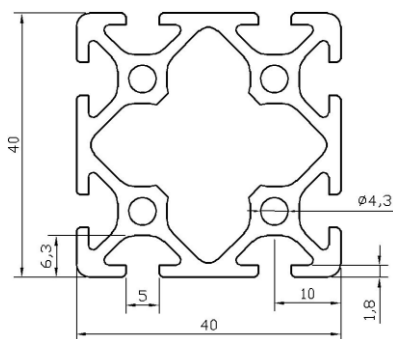
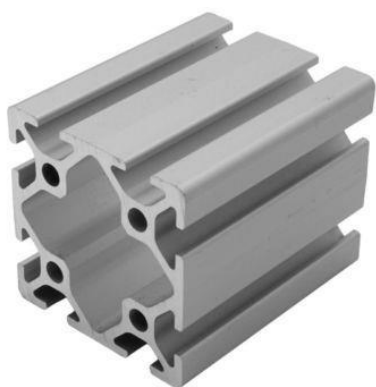
GPB.1.2040**GPB.1.2060****GPB.1.4040**

| Oznaczenie handlowe | Waga [kg] |
|---------------------|-----------|
| GPB.1.1020 | 0,35 |
| GPB.1.1040 | 0,64 |
| GPB.1.2040 | 0,95 |
| GPB.1.4040 | 1,81 |
| GPB.1.2020 | 0,49 |
| GPB.1.2060 | 1,28 |

► Profile aluminiowe o przekroju okrągłym

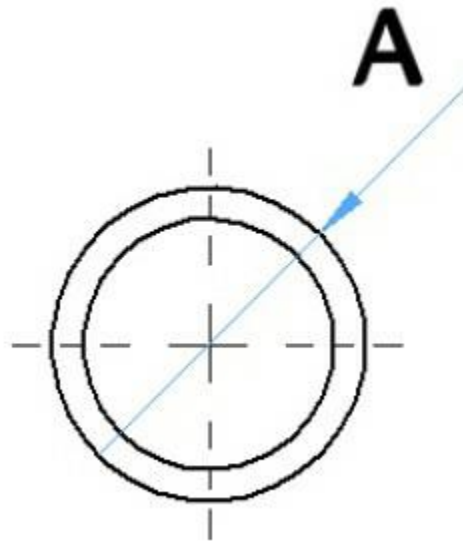

| Oznaczenie handlowe | Waga [kg] | Średnica [mm] |
|---------------------|-----------|---------------|
| GP.1.10.O | 0,076 | 10 |
| GP.1.14.O | 0,16 | 14 |
| GP.1.20.O | 0,23 | 20 |
| GP.1.30.O | 0,444 | 30 |

1.2 Zaślepki



| Oznaczenie handlowe |
|---------------------|
| GP.V.2525 |
| GP.V.5025 |

1.3 Wsuwki

► Wsuwka typu A (materiał - stal ocynkowana)

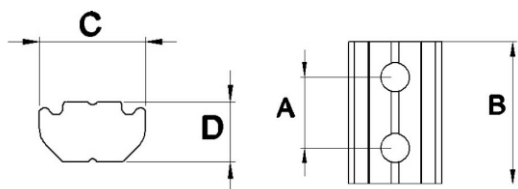

D - 5 mm

C - 8 mm



| Oznaczenie handlowe | Gwint | A [mm] | B [mm] | Waga [g] | |
|---------------------|-------|--------|--------|----------|----------|
| | | | | Wersja N | Wersja L |
| GP.A.2.1 | M4 | | 15 | 4 | |
| GP.A.2.2 | M4 | 8 | 16 | 8 | 6 |
| GP.A.2.3 | M5 | | 12 | 4 | |
| GP.A.2.4 | M5 | | 15 | 5 | |
| GP.A.2.6 | M5 | 10 | 20 | 9 | 7 |
| GP.A.2.7 | M5 | 12 | 22 | 9 | 7 |
| GP.A.2.8 | M5 | 15 | 25 | 9 | 7 |
| GP.A.2.9 | M5 | 17 | 25 | 9 | 7 |
| GP.A.2.10 | M5 | 22 | 32 | 11 | 8 |
| GP.A.2.11 | M5 | 25 | 35 | 13 | 9 |
| GP.A.2.12 | M5 | 28 | 38 | 14 | 10 |
| GP.A.2.13 | M5 | 30 | 40 | 15 | 11 |
| GP.A.2.14 | M5 | 35 | 45 | 16 | 11 |
| GP.A.2.15 | M5 | 40 | 50 | 18 | 13 |
| GP.A.2.16 | M5 | 50 | 60 | 22 | 14 |
| GP.A.2.17 | M5 | 60 | 70 | 26 | 16 |
| GP.A.2.18 | M6 | | 15 | 5 | |
| GP.A.2.19 | M5 | 90 | 100 | 38 | 24 |

* N - Normalna ; L - Lekka

► Wsuwka typu B (materiał - stal ocynkowana)

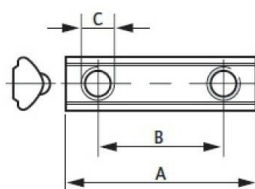
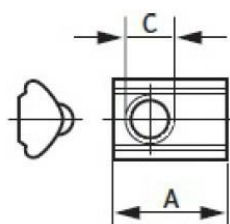

| Oznaczenie handlowe | Gwint | B [mm] | A [mm] | Waga [g] |
|---------------------|-------|--------|--------|----------|
| GP.B.2.1 | M4 | | 12 | 2 |
| GP.B.2.2 | M4 | 8 | 16 | 3 |
| GP.B.2.3 | M5 | | 12 | 2 |
| GP.B.2.4 | M5 | 10 | 20 | 3 |
| GP.B.2.5 | M5 | 12 | 22 | 4 |
| GP.B.2.6 | M5 | 12 | 25 | 5 |
| GP.B.2.8 | M5 | 20 | 30 | 6 |
| GP.B.2.9 | M5 | 25 | 35 | 7 |
| GP.B.2.10 | M5 | 30 | 40 | 8 |
| GP.B.2.11 | M5 | 50 | 60 | 12 |

2. Łączniki

2.1 Łączniki Montażowe

► Łączniki krzyżowe serii 5 (wsuwki typu B)

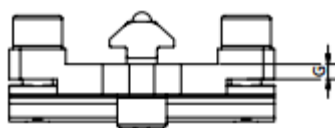

| Oznaczenie handlowe | A [mm] | B [mm] |
|---------------------|--------|--------|
| GP.HG.2020 | 20 | 20 |
| GP.HG.2040 | 20 | 40 |
| GP.HG.4040 | 40 | 40 |

► Łączniki krzyżowe serii 6 (wsuwki typu A)

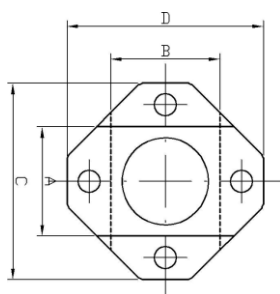

| Oznaczenie handlowe | A [mm] | B [mm] | C [mm] | D [mm] | Waga [g] |
|---------------------|--------|--------|--------|--------|----------|
| GP.1825 | 18 | 25 | 38 | 45 | 60 |
| GP.2525 | 25 | 25 | 45 | 45 | 75 |
| GP.2525.1* | 25 | 25 | 45 | 45 | 70 |
| GP.5050 | 50 | 50 | 70 | 70 | 170 |
| GP.2550 | 25 | 50 | 45 | 70 | 155 |

* Grubość 5mm, bez wyfrezowań

► Łączniki krzyżowe - Pozostałe

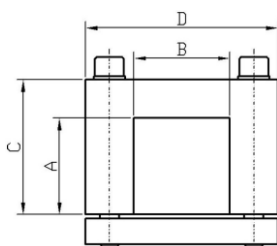
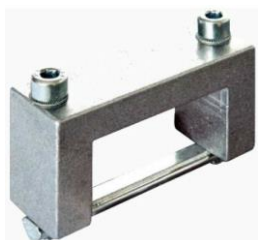

| Oznaczenie handlowe | A [mm] | B [mm] | C [mm] | D [mm] | Waga [g] |
|---------------------|--------|--------|--------|--------|----------|
| GP.HG.1020 | 10 | 20 | 18 | 40 | 43 |
| GP.HG.1040 | 10 | 40 | 18 | 60 | 58 |
| GP.HG.2040.1 | 20 | 40 | 28 | 60 | 72 |
| GP.HG.1020.1 | 20 | 10 | 28 | 30 | 50 |
| GP.HG.2020.1 | 20 | 20 | 28 | 40 | 57 |
| GP.HG.2040.2 | 40 | 20 | 48 | 40 | 82 |
| GP.HG.4040.1 | 40 | 40 | 48 | 60 | 96 |
| GP.HG.1818 | 18 | 18 | 29 | 38 | 32 |
| GP.HG.2525 | 25 | 25 | 32 | 45 | 45 |
| GP.HG.5025 | 50 | 25 | 78 | 45 | 65 |
| GP.HG.2550 | 25 | 50 | 32 | 70 | 50 |

► Łączniki kątowe

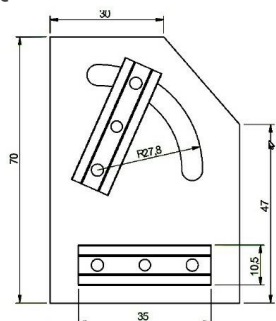

| Oznaczenie handlowe |
|---------------------|
| GP.GK08 |

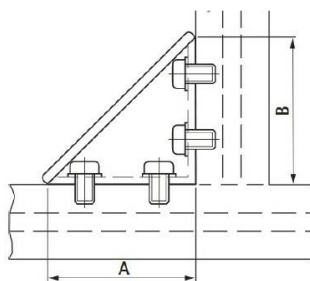

| Oznaczenie handlowe | A [mm] | B [mm] |
|---------------------|--------|--------|
| GP.HG.2020.2 | 20 | 20 |
| GP.HG.4040.2 | 40 | 40 |
| GP.HG.2525.2 | 25 | 25 |
| GP.HG.5050.2 | 50 | 50 |

► Łączniki Proste

UWAGA - ŁĄCZNIKI SPRZEDAJE SIĘ W KOMPLECIE Z WSUWKAMI A LUB B, W ZALEŻNOŚCI OD RODZAJU PROFILU

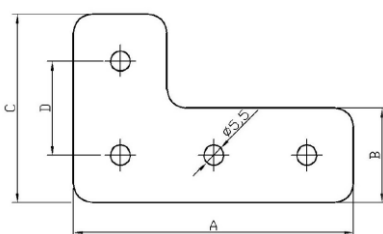

| Oznaczenie handlowe | A [mm] | B [mm] | C [mm] | D [mm] |
|---------------------|--------|--------|--------|--------|
| GP.3.1.L | 70 | 20 | 40 | 20 |
| GP.3.2.L | 50 | 25 | 50 | 25 |
| GP.3.3.L | 75 | 25 | 50 | 25 |
| GP.3.4.L | 120 | 40 | 80 | 40 |

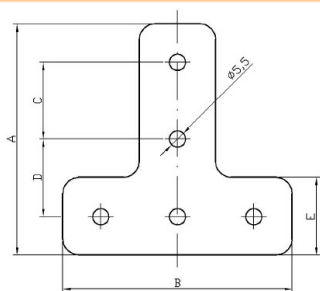

| Oznaczenie handlowe | A [mm] | B [mm] | C [mm] | D [mm] | E [mm] |
|---------------------|--------|--------|--------|--------|--------|
| GP.3.1.T | 70 | 70 | 20 | 20 | 20 |
| GP.3.2.T | 75 | 75 | 25 | 25 | 25 |
| GP.3.3.T | 110 | 120 | 40 | 40 | 40 |

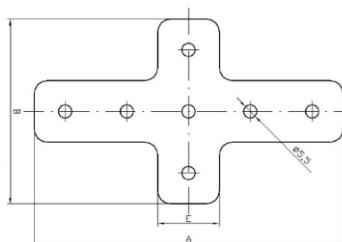

| Oznaczenie handlowe | A [mm] | B [mm] | C [mm] | D [mm] | E [mm] |
|---------------------|--------|--------|--------|--------|--------|
| GP.GK.125 | 125 | 75 | 25 | 53 | 25 |

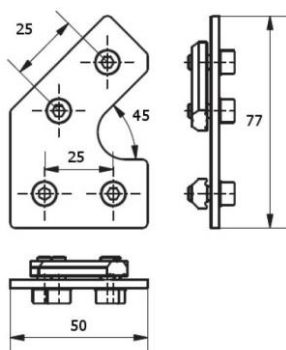

| Oznaczenie handlowe |
|---------------------|
| GP.HG.45 |

2.2 Szybkozłącza

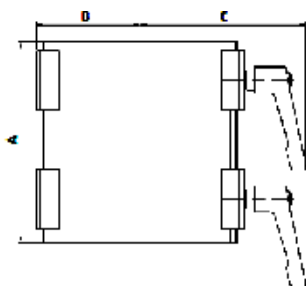
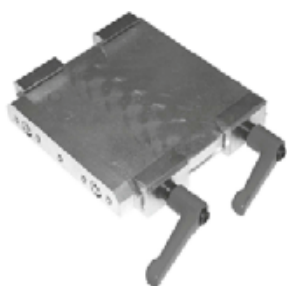

| Oznaczenie handlowe | A [mm] | B [mm] | C [mm] |
|---------------------|--------|--------|--------|
| GP.M0 | 60 | 38 | 43 |
| GP.M1 | 102 | 58 | 95 |
| GP.M2 | 160 | 101 | 132 |

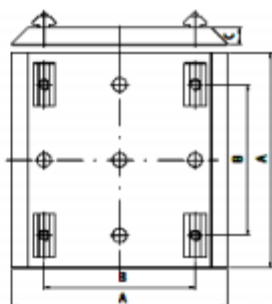
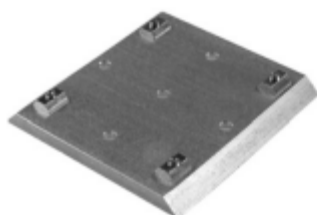

| Oznaczenie handlowe | A [mm] | B [mm] | C [mm] |
|---------------------|--------|--------|--------|
| GP.S0 | 60 | 35 | 8 |
| GP.S1 | 100 | 35 | 8 |
| GP.S2 | 160 | 70 | 10 |



| Oznaczenie handlowe |
|---------------------|
| GP.QM.50 |
| GP.QM.90 |
| GP.QM.150 |

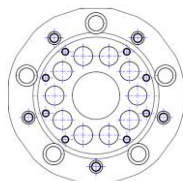

| Oznaczenie handlowe |
|---------------------|
| GP.QS.50 |
| GP.QS.90 |
| GP.QS.150 |

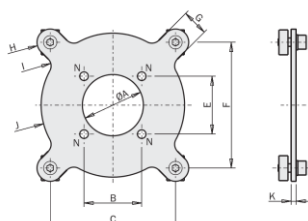

| Oznaczenie handlowe |
|---------------------|
| GP.QZ.50 |
| GP.QZ.90 |
| GP.QZ.150 |

3. Zaciski

3.1 Zaciski Montażowe

- ▶ Zaciski do profili Aluminiowych o przekroju Okrągłym

GP.R.Z.1

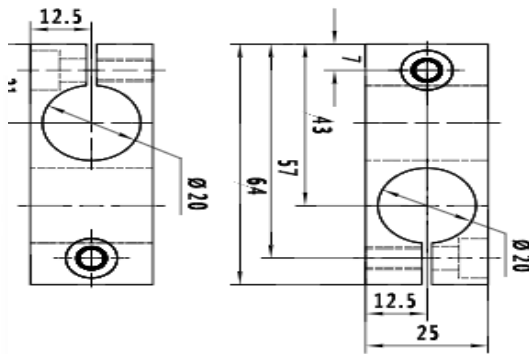

GP.R.Z.2

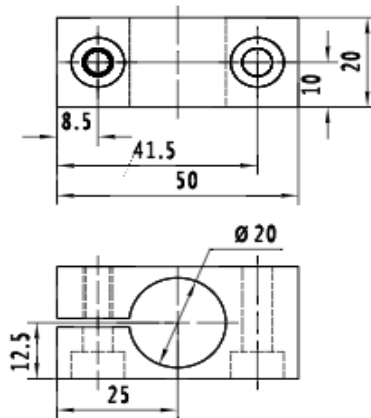

GP.R.Z.3

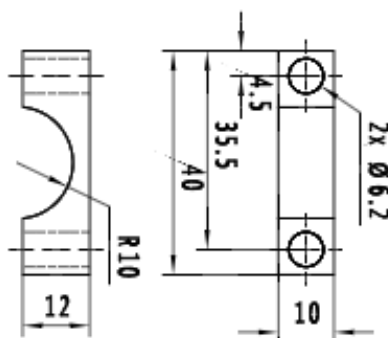

GP.R.Z.4

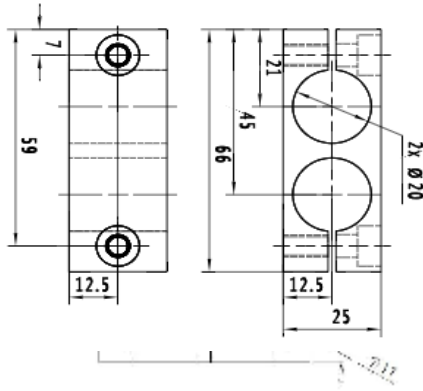

GP.R.Z.5

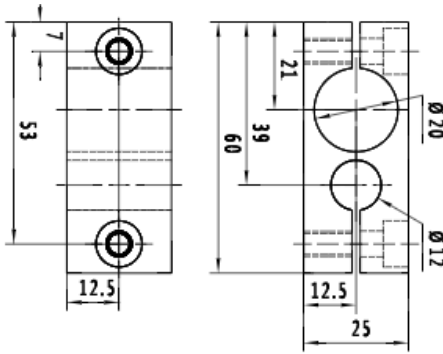

GP.R.Z.7

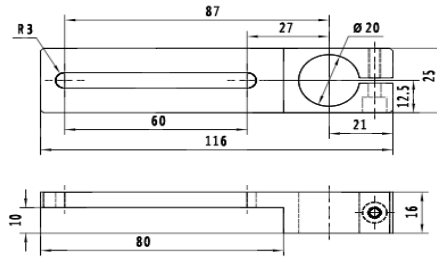
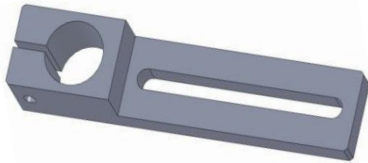

GP.R.Z.8

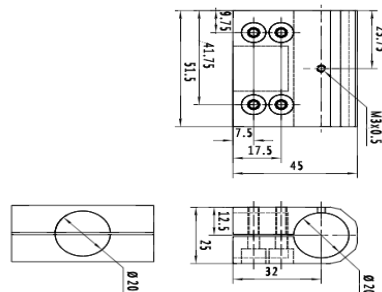

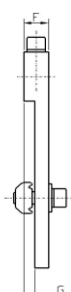
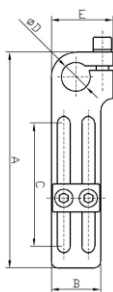

| Oznaczenie handle | A [mm] | B [mm] | C [mm] | D [mm] | E [mm] | F [mm] | G [mm] | Waga [g] |
|-------------------|--------|--------|--------|--------|--------|--------|--------|----------|
| GP.GK.30 | 70 | 16 | 40 | 10 | 20 | 8 | 3,5 | 23 |
| GP.GK.31 | 75 | 20 | 40 | 14 | 25 | 12 | 6 | 38 |
| GP.GK.32 | 85 | 20 | 50 | 20 | 25 | 12 | 6 | 40 |
| GP.GK.33 | 105 | 25 | 60 | 20 | 30 | 12 | 6 | 55 |

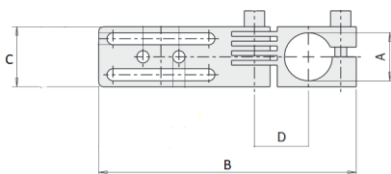

| Oznaczenie handle | A [mm] | B [mm] | C [mm] | D [mm] |
|-------------------|--------|--------|--------|--------|
| GP.GK.20 | 10 | 62 | 15 | 15 |
| GP.GK.21 | 14 | 80 | 25 | 20 |
| GP.GK.22 | 20 | 104 | 25 | 25 |

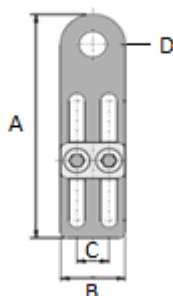

| Oznaczenie handle | A [mm] | B [mm] | C [mm] | D [mm] | E [mm] |
|-------------------|--------|--------|--------|--------|--------|
| GP.GK.40 | 65 | 22 | 12 | G1/8 | 25 |
| GP.GK.40.1 | 100 | 22 | 12 | G1/8 | 40 |
| GP.GK.41 | 65 | 22 | 12 | M10x1 | 25 |
| GP.GK.41.1 | 100 | 22 | 12 | M10x1 | 40 |
| GP.GK.42 | 65 | 22 | 12 | M14x1 | 25 |
| GP.GK.42.2 | 100 | 22 | 12 | M14x1 | 40 |
| GP.GK.43 | 65 | 22 | 12 | M16x1 | 25 |
| GP.GK.43.3 | 100 | 22 | 12 | M16x1 | 40 |

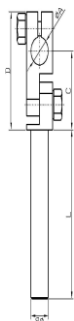
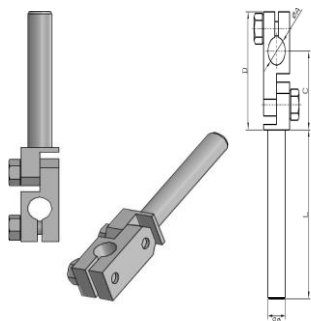

| Oznaczenie handle | A [mm] | B [mm] | C [mm] | D [mm] | L [mm] | Waga [g] |
|-------------------|--------|--------|--------|--------|--------|----------|
| GP.ZP.10 | 10 | 10 | 27 | 40 | 60 | 32 |
| GP.ZP.14 | 14 | 14 | 34 | 52 | 90 | 68 |
| GP.ZP.20 | 20 | 20 | 42 | 63 | 90 | 144 |
| GP.ZP.1014 | 10 | 14 | 34 | 52 | 90 | 53 |
| GP.ZP.1420 | 14 | 20 | 42 | 63 | 90 | 120 |

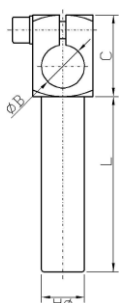
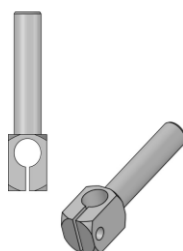

| Oznaczenie handle | A [mm] | B [mm] | C [mm] | L [mm] | Waga [g] |
|-------------------|--------|--------|--------|--------|----------|
| GP.L.10 | 10 | 10 | 20 | 60 | 15 |
| GP.L.14 | 14 | 14 | 27 | 90 | 37 |
| GP.L.20 | 20 | 20 | 33 | 90 | 72 |

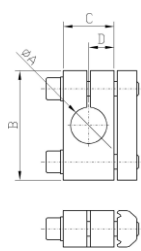

| Oznaczenie handlowe | A [mm] | B [mm] | C [mm] | D [mm] | Waga [g] |
|---------------------|--------|--------|--------|--------|----------|
| GP.GK.50 | 10 | 30 | 14 | 7 | 25 |
| GP.GK.51 | 14 | 35 | 19 | 9,5 | 32 |
| GP.GK.52 | 20 | 40 | 24 | 12 | 41 |

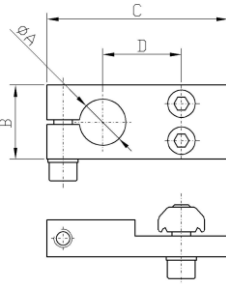

| Oznaczenie handlowe | A [mm] | B [mm] | C [mm] | D [mm] | Waga [g] |
|---------------------|--------|--------|--------|--------|----------|
| GP.GK.60 | 10 | 16 | 39 | 17 | 25 |
| GP.GK.61 | 14 | 20 | 46 | 19 | 32 |
| GP.GK.62 | 20 | 25 | 51 | 22 | 41 |

► Dyspensery Sprężynowe

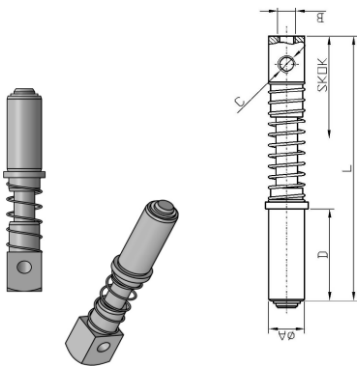

| Oznaczenie handlowe | A [mm] | B [mm] | C [mm] | D [mm] | L [mm] | Skok [mm] | Waga [g] |
|---------------------|--------|--------|--------|--------|--------|-----------|----------|
| GP.Z.10.10 | 10 | M5 | M5 | 26 | 58 | 10 | 12 |
| GP.Z.10.20 | 10 | M5 | M5 | 26 | 76 | 20 | 14 |
| GP.Z.14.15 | 14 | G1/8 | G1/8 | 32 | 80 | 15 | 31 |
| GP.Z.14.35 | 14 | G1/8 | G1/8 | 32 | 105 | 35 | 34 |
| GP.Z.14.15.1 | 14 | G1/4 | G1/8 | 32 | 80 | 15 | 38 |
| GP.Z.14.35.1 | 14 | G1/4 | G1/8 | 32 | 105 | 35 | 41 |
| GP.Z.20.20 | 20 | G1/8 | G1/8 | 53 | 109 | 20 | 74 |
| GP.Z.20.20.1 | 20 | G1/4 | G1/4 | 53 | 113 | 20 | 61 |
| GP.Z.20.40 | 20 | G1/8 | G1/8 | 53 | 135 | 40 | 90 |
| GP.Z.20.40.1 | 20 | G1/4 | G1/4 | 53 | 139 | 40 | 77 |



| Oznaczenie handlowe | A [mm] | B [mm] | C [mm] | D [mm] | L [mm] | Skok [mm] | Waga [g] |
|---------------------|--------|--------|--------|--------|--------|-----------|----------|
| GP.ZH.1 | 10 | M5 | M5 | 26 | 62 | 10 | 21 |
| GP.ZH.2 | 10 | M5 | M5 | 26 | 80 | 20 | 33 |
| GP.ZH.3 | 14 | G1/8 | G1/8 | 32 | 80 | 15 | 83 |
| GP.ZH.4 | 14 | G1/8 | G1/8 | 32 | 105 | 35 | 33 |
| GP.ZH.3.1 | 14 | G1/4 | G1/8 | 32 | 87 | 15 | 76 |
| GP.ZH.4.1 | 14 | G1/4 | G1/8 | 32 | 112 | 35 | 77 |
| GP.ZH.5 | 20 | G1/8 | G1/8 | 53 | 117 | 20 | 145 |
| GP.ZH.5.1 | 20 | G1/4 | G1/4 | 53 | 119 | 20 | 168 |
| GP.ZH.6 | 20 | G1/8 | G1/8 | 53 | 143 | 40 | 146 |
| GP.ZH.6.1 | 20 | G1/4 | G1/4 | 53 | 119 | 40 | 169 |

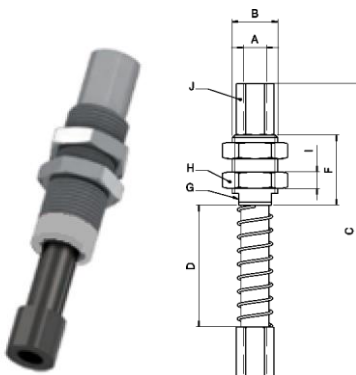
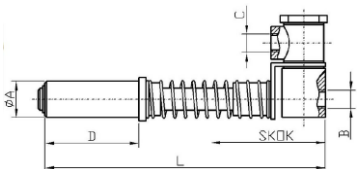

| Oznaczenie handlowe | A [mm] | B [mm] | C [mm] | D [mm] | Waga [g] |
|---------------------|--------|--------|--------|--------|----------|
| GP.Z.40 | M5 | G1/8 | 63 | 26 | 23 |
| GP.Z.40.NR* | M5 | G1/8 | 63 | 26 | 23 |
| GP.Z.40.1 | M5 | G1/8 | 78 | 26 | 28 |
| GP.Z.40.1.NR* | M5 | G1/8 | 63 | 26 | 28 |
| GP.Z.25 | G1/8 | M16x1 | 92 | | 100 |
| GP.Z.50 | G1/8 | M16x1 | 122 | 64 | 112 |
| GP.Z.25.NR* | G1/8 | M16x1 | 92 | 34 | 100 |
| GP.Z.50.NR* | G1/8 | M16x1 | 122 | 64 | 112 |

*NR - zabezpieczenie przed obrotem

3.2 Mocowania Ssawek

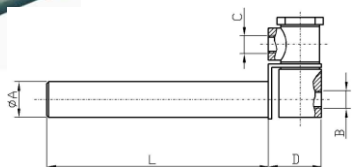

| Oznaczenie handlowe | A [mm] | B [mm] | C [mm] | D [mm] | L [mm] | Waga [g] |
|---------------------|--------|--------|--------|--------|--------|----------|
| GP.ZL.10 | 10 | M5 | M5 | 16 | 90 | 26 |
| GP.ZL.14 | 14 | G1/8 | G1/8 | 24 | 90 | 68 |
| GP.ZL.20 | 20 | G1/8 | G1/8 | 30 | 90 | 116 |

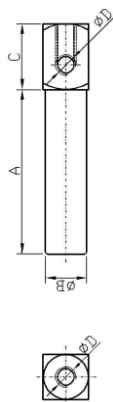
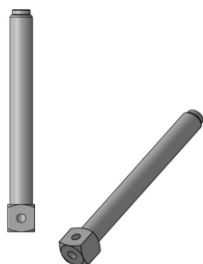

| Oznaczenie handlowe | A [mm] | B [mm] | C [mm] | D [mm] | Waga [g] |
|---------------------|--------|--------|--------|--------|----------|
| GP.Z.10 | 90 | 10 | 8 | M5 | 21 |
| GP.Z.14 | 90 | 14 | 13,5 | G1/8 | 33 |
| GP.Z.20 | 90 | 20 | 18 | G1/8 | 83 |

GP.MS.1

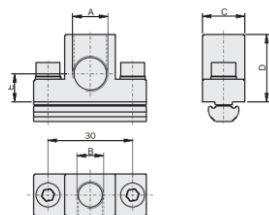

GP.MS.2

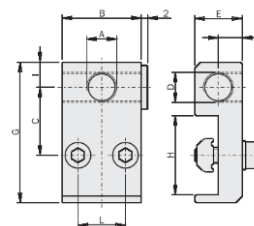

GP.MS.3

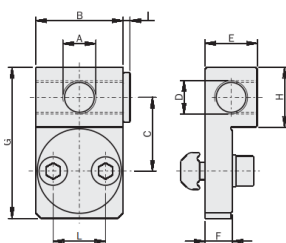

GP.MS.4

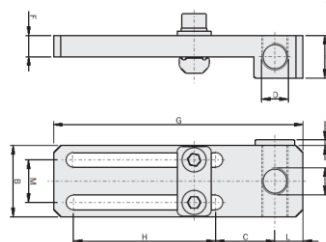

| Oznaczenie handlowe | A [mm] | B [mm] | C [mm] | D [mm] | E [mm] |
|---------------------|--------|--------|--------|--------|--------|
| GP.MS.1 | G1/8 | G1/8 | 15 | 24 | 12 |
| GP.MS.2 | G1/8 | 25 | 20 | G1/8 | 15 |
| GP.MS.3 | G1/8 | 25 | 20 | G1/8 | 15 |
| GP.MS.4 | G1/8 | 20 | 18 | G1/8 | 12 |

4. Ssawki

4.1 Ssawki Próżniowe

- Jedno-materiałowe (Silikon, NBR, HNBR)

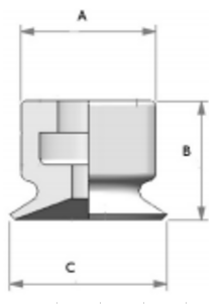

| Oznaczenie handlowe | A [mm] | B [mm] | C [mm] | Nypel |
|---------------------|--------|--------|--------|------------|
| GP.S10 | 8,5 | 7,5 | 10 | GP-N.05/06 |
| GP.S15 | 16 | 13 | 15 | GP-N.05/06 |
| GP.S20 | 16 | 13 | 20 | GP-N.05/06 |
| GP.S25 | 16 | 13 | 25 | GP-N.05/06 |
| GP.S30 | 16 | 10 | 30 | GP-N.05/06 |
| GP.S40 | 20 | 15 | 40 | GP-N.05/06 |

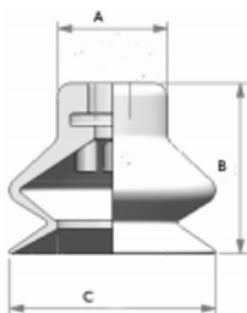

| Oznaczenie handlowe | A [mm] | B [mm] | C [mm] | Nypel |
|---------------------|--------|--------|--------|------------|
| GP.S10.1 | 16 | 16,5 | 10 | GP-N.05/06 |
| GP.S15.1 | 16 | 16,5 | 15 | GP-N.05/06 |
| GP.S20.1 | 16 | 16,5 | 20 | GP-N.05/06 |
| GP.S25.1 | 16 | 16,5 | 25 | GP-N.05/06 |
| GP.S30.1 | 16 | 25 | 30 | GP-N.05/06 |
| GP.S40.1 | 16 | 26,5 | 40 | GP-N.05/06 |
| GP.S15.1S | 16 | 16,5 | 15 | GP-N.05/06 |
| GP.S20.1S | 16 | 16,5 | 20 | GP-N.05/06 |
| GP.S25.1S | 16 | 16,5 | 25 | GP-N.05/06 |
| GP.S30.1S | 16 | 25 | 30 | GP-N.05/06 |
| GP.S40.1S | 16 | 26,5 | 40 | GP-N.05/06 |

S - Ssawki do powierzchni porowatych

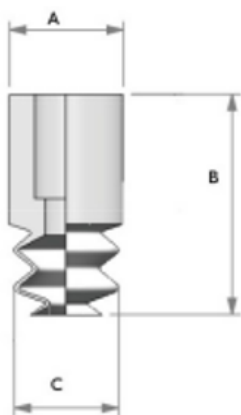

| Oznaczenie handlowe | A [mm] | B [mm] | C [mm] | Nypel |
|---------------------|--------|--------|--------|------------|
| GP.S04.2 | 6,75 | 14 | 4 | GP-N.04 |
| GP.S05.2 | 7 | 13,5 | 5 | GP-N.04 |
| GP.S09.2 | 8 | 15 | 9 | GP-N.04 |
| GP.S11.2 | 8 | 15 | 11 | GP-N.04 |
| GP.S14.2 | 9 | 18 | 14 | GP-N.01/02 |
| GP.S18.2 | 10 | 22 | 18 | GP-N.01/02 |
| GP.S20.2 | 10 | 22 | 20 | GP-N.01/02 |
| GP.S25.2 | 10 | 33 | 25 | GP-N.01/02 |
| GP.S30.2 | 10 | 33 | 30 | GP-N.03 |
| GP.S43.2 | 18 | 46 | 43 | GP-N.03 |
| GP.S52.2 | 19 | 42 | 52 | GP-N.03 |
| GP.S.60.2 | 19 | 55 | 60 | GP-N.03 |

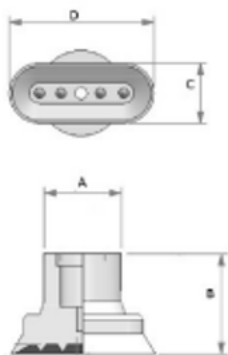

| Oznaczenie handlowe | A [mm] | B [mm] | C [mm] | D [mm] | Nypel |
|---------------------|--------|--------|--------|--------|---------|
| GP.S0515 | 9 | 11,5 | 5 | 15 | GP-N.02 |
| GP.S0618 | 9 | 12 | 6 | 18 | GP-N.02 |
| GP.S0824 | 12 | 12 | 8 | 24 | GP-N.02 |
| GP.S1030 | 12 | 12 | 10 | 30 | GP-N.02 |
| GP.S1236 | 12 | 12 | 12 | 36 | GP-N.02 |

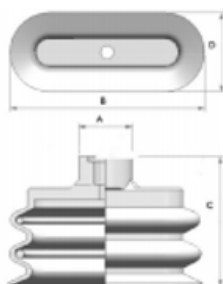

| Oznaczenie handlowe | A [mm] | B [mm] | C [mm] | D [mm] | Nypel |
|---------------------|--------|--------|--------|--------|---------|
| GP.S0825.1 | 10 | 25 | 18,5 | 8 | GP-N.08 |
| GP.S1545.1 | 17,5 | 45 | 28,5 | 15 | GP-N.08 |
| GP.S2570.1 | 17,5 | 75 | 34,5 | 25 | GP-N.08 |

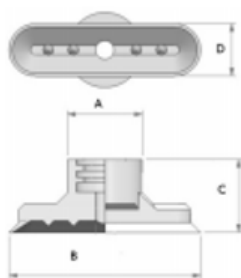

| Oznaczenie handlowe | A [mm] | B [mm] | C [mm] | D [mm] | Nypel |
|---------------------|--------|--------|--------|--------|---------|
| GP.S1545.1 | 17 | 45 | 21 | 15 | GP-N.07 |
| GP.S2060 | 17 | 60 | 21 | 20 | GP-N.07 |
| GP.S2575 | 18 | 75 | 22 | 25 | GP-N.07 |

► Dwu-materiałowe (60/30 shore)

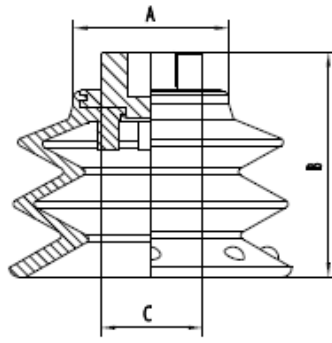
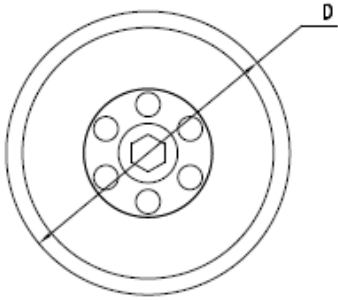

| Oznaczenie handlowe | A [mm] | B [mm] | C [mm] | D [mm] | Nypel |
|---------------------|--------|--------|--------|--------|------------|
| GP.S20.3 | 12 | 14,8 | 11,7 | 20,5 | GP-N.10/11 |
| GP.S30.3 | 16,5 | 21,3 | 13,1 | 30 | GP-N.10/11 |
| GP.S40.3 | 22 | 28,4 | 17,5 | 40 | GP-N.12/13 |
| GP.S50.3 | 27,5 | 35,5 | 21,9 | 50 | GP-N.14/15 |
| GP.S70.3 | 39 | 58,5 | 31,3 | 70 | GP-N.20 |

4.2 Nypel

GP.N.01

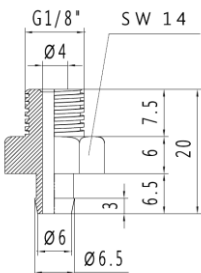

GP.N.02

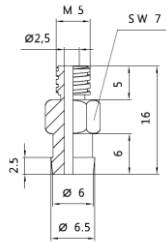

GP.N.03

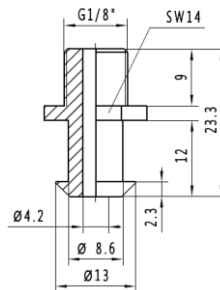

GP.N.04

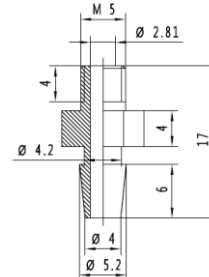

GP.N.05

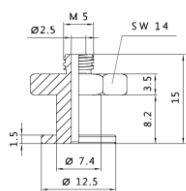

GP.N.06

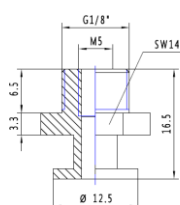

GP.N.07

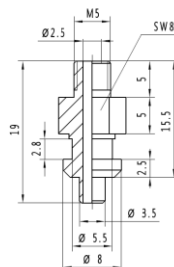

GP.N.08

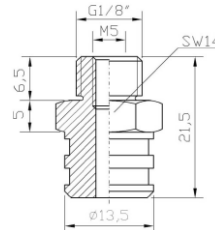

GP.N.09

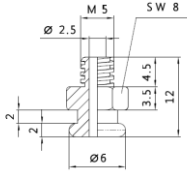

GP.N.10

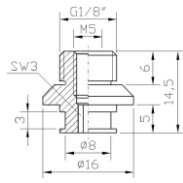

GP.N.11

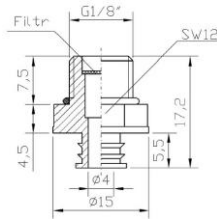

GP.N.12

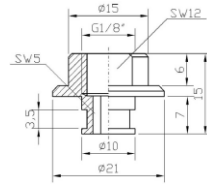

GP.N.13

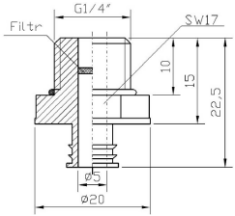

GP.N.14

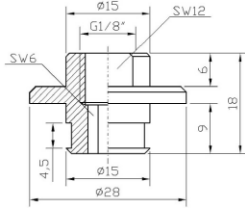

GP.N.15

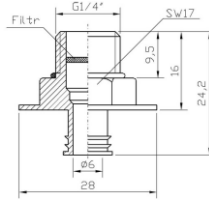

GP.N.16

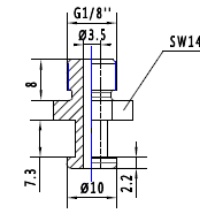

GP.N.17

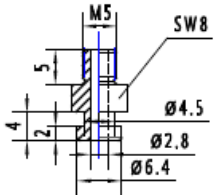

GP.N.18

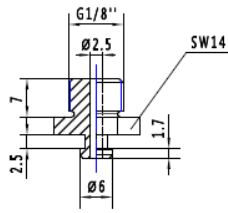

GP.N.19

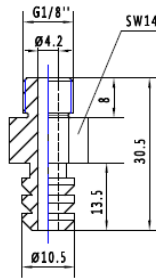

GP.N.20

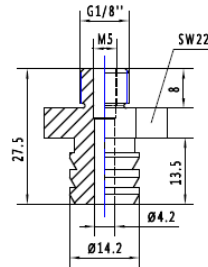

GP.N.21

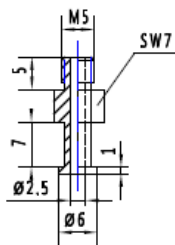

GP.N.22

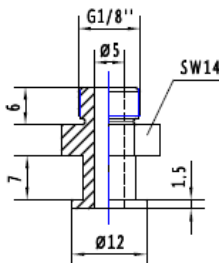

5. Chwytaki

► Chwytaki Równoległe

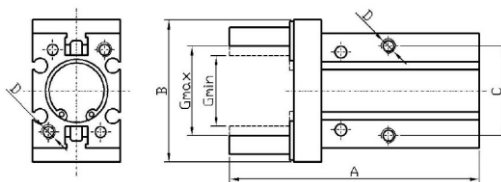

| Oznaczenie handlowe | A [mm] | B [mm] | C [mm] | D [mm] | G min [mm] | G max [mm] | Waga [g] |
|---------------------|--------|--------|--------|--------|------------|------------|----------|
| GP.R.06 | 53 | 20 | 12 | M3 | 8 | 12 | 27 |
| GP.R.10 | 57 | 29 | 16 | M3 | 11,2 | 15,2 | 55 |
| GP.R.16 | 67 | 38 | 24 | M4 | 14,9 | 20,9 | 115 |
| GP.R.20 | 84 | 50 | 30 | M5 | 16,3 | 26,3 | 235 |
| GP.R.25 | 102 | 63 | 36 | M6 | 19,3 | 33,3 | 430 |

► Chwytaki Równoległe z długim skokiem

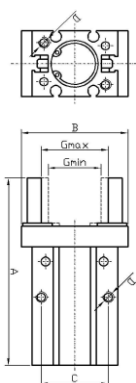

| Oznaczenie handlowe | A [mm] | B [mm] | C [mm] | D [mm] | G min [mm] | G max [mm] | Waga [g] |
|---------------------|--------|--------|--------|--------|------------|------------|----------|
| GP.RL.10 | 57 | 35 | 16 | M3 | 11,5 | 19,2 | 60 |
| GP.RL.16 | 70 | 47 | 24 | M4 | 14,9 | 26,9 | 135 |
| GP.RL.20 | 90 | 62 | 30 | M5 | 16,3 | 34,3 | 270 |
| GP.RL.25 | 106 | 75 | 36 | M6 | 19,3 | 41,3 | 460 |

► Chwytaki kątowe o kącie rozwarcia szczęk 180°

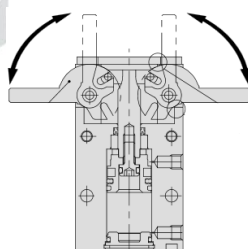

| Oznaczenie handlowe | A [mm] | B [mm] | C [mm] | G [mm] | H [mm] | Waga [g] |
|---------------------|--------|--------|--------|--------|--------|----------|
| GP.Y.10 | 58 | 15 | 30 | 22 | 23,5 | 70 |
| GP.Y.16 | 69 | 20 | 38 | 28 | 28,5 | 150 |
| GP.Y.20 | 86 | 26 | 48 | 36 | 37 | 320 |
| GP.Y.25 | 107 | 30 | 58 | 37 | 45 | 560 |

► Chwytki kątowe, o kącie rozwarcia szczęk 30°

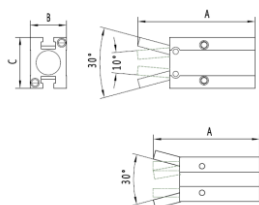

| Oznaczenie handlowe | A [mm] | B [mm] | C [mm] | Waga [g] |
|---------------------|--------|--------|--------|----------|
| GP.C.06 | 41 | 10 | 20 | 22 |
| GP.C.10 | 52 | 16 | 23 | 39 |
| GP.C.16 | 62 | 23 | 30 | 91 |
| GP.C.20 | 78 | 27 | 42 | 180 |
| GP.C.25 | 92 | 33 | 52 | 311 |

► Chwytki Równoległe o szerokim rozstawie szczęk

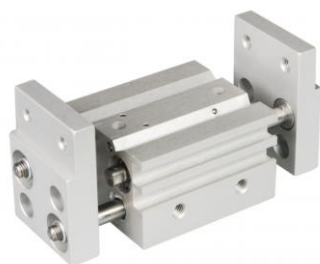
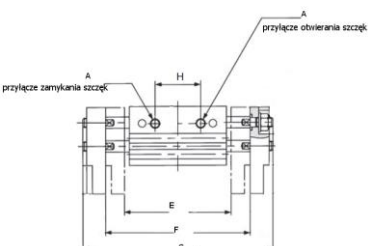

| Oznaczenie handlowe | A [mm] | E [mm] | F [mm] | G [mm] | H [mm] | Waga [g] |
|---------------------|--------|--------|--------|--------|--------|----------|
| GP.L.10 | M5 | 56 | 76 | 100 | 24 | 280 |
| GP.L.10.1 | M5 | 78 | 118 | 142 | 39 | 345 |
| GP.L.10.2 | M5 | 96 | 156 | 180 | 57 | 425 |
| GP.L.16 | M5 | 68 | 76 | 98 | 26 | 585 |
| GP.L.16.1 | M5 | 110 | 118 | 170 | 50 | 795 |
| GP.L.16.2 | M5 | 130 | 156 | 210 | 70 | 935 |
| GP.L.20 | M5 | 82 | 122 | 160 | 32 | 1025 |
| GP.L.20.1 | M5 | 242 | 222 | 260 | 68 | 1495 |
| GP.L.20.2 | M5 | 162 | 262 | 300 | 88 | 1690 |
| GP.L.25 | M5 | 100 | 150 | 196 | 38 | 1690 |
| GP.L.25.1 | M5 | 181 | 182 | 328 | 86 | 2560 |
| GP.L.25.2 | M5 | 200 | 200 | 366 | 104 | 2775 |
| GP.L.32 | G1/8 | 150 | 220 | 272 | 56 | 2905 |
| GP.L.32.1 | G1/8 | 198 | 318 | 370 | 104 | 3820 |
| GP.L.32.2 | G1/8 | 242 | 402 | 454 | 148 | 4655 |
| GP.L.40 | G1/8 | 188 | 288 | 348 | 72 | 5270 |
| GP.L.40.1 | G1/8 | 246 | 406 | 466 | 130 | 6830 |
| GP.L.40.2 | G1/8 | 286 | 486 | 546 | 170 | 7905 |

► Mocowanie Chwytków - Płyta

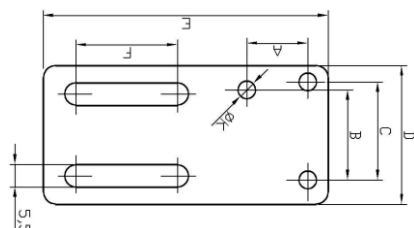

| Oznaczenie handlowe | A [mm] | B [mm] | C [mm] | D [mm] | E [mm] | F [mm] | K [mm] |
|---------------------|--------|--------|--------|--------|--------|--------|--------|
| GP.R.P.06 | | 12 | | 20 | 50 | 25 | 3,3 |
| GP.R.P.10 | 12 | 18 | 16 | 23 | 70 | 25 | 3,3 |
| GP.R.P.16 | 15 | 22 | 24 | 31 | 70 | 25 | 4,4 |
| GP.R.P.20 | 18 | 32 | 30 | 42 | 70 | 25 | 5,5 |
| GP.R.P.25 | 32 | 40 | 36 | 52 | 80 | 25 | 8,5 |

► Mocowanie Chwytków - Stopa

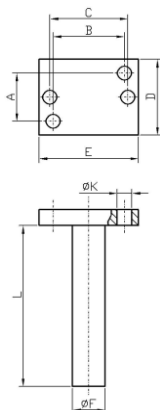

| Oznaczenie handlowe | A [mm] | B [mm] | C [mm] | D [mm] | E [mm] | K [mm] | L [mm] |
|---------------------|--------|--------|--------|--------|--------|--------|--------|
| GP.R.S.10 | 12 | 18 | 16 | 16,5 | 10 | 3,3 | 50 |
| GP.R.S.10 NR | 12 | 18 | 16 | 16,5 | 10 | 3,3 | 50 |
| GP.R.S.16 | 15 | 22 | 24 | 23,6 | 10 | 4,3 | 50 |
| GP.R.S.16 NR | 15 | 22 | 24 | 23,6 | 10 | 4,3 | 50 |
| GP.R.S.20 | 18 | 32 | 30 | 27,6 | 14 | 5,5 | 70 |
| GP.R.S.20 NR | 18 | 32 | 30 | 27,6 | 14 | 5,5 | 70 |
| GP.R.S.25 | 40 | 36 | 36 | 33,6 | 14 | 6,5 | 70 |
| GP.R.S.25 NR | 40 | 36 | 36 | 33,6 | 14 | 6,5 | 70 |

► Chwytaki Serii 20

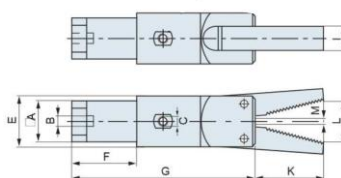

| Oznaczenie handlowe | A [mm] | B [mm] | C [mm] | E [mm] | F [mm] | G [mm] | I [mm] | K [mm] | L [mm] | M [mm] |
|---------------------|--------|--------|--------|--------|--------|--------|--------|--------|--------|--------|
| GP.HW.7 | 20 | M5 | M5 | 25 | 30 | 100 | 12 | 36 | 18 | 2 |

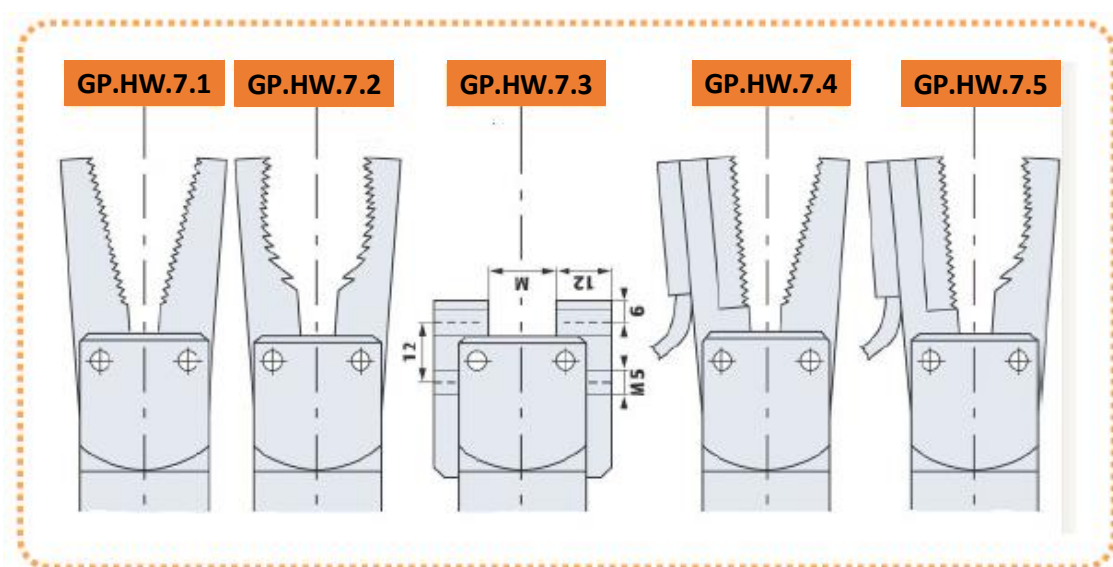

6. Obcinaki

► Obcinaki Grupy NY



| Oznaczenie handlowe | A [mm] | B [mm] | C [mm] |
|---------------------|--------|--------|--------|
| GT-NY05 | 75,9 | 23 | 47,6 |
| GT-NY10 | 82,1 | 28 | 51,6 |
| GT-NY15 | 93 | 33 | 58 |
| GT-NY25 | 108,5 | 42 | 69 |

► Noże do Obcinaków Grupy NY



| Oznaczenie handlowe |
|---------------------|
| NY05AJ |
| NY10AJ |
| NY15AJ |
| NY25AJ |

| Oznaczenie handlowe |
|---------------------|
| NY05AJL |
| NY10AJL |
| NY15AJL |
| NY25AJL |

| Oznaczenie handlowe |
|---------------------|
| NY05AJT |
| NY10AJT |
| NY15AJT |

► Obcinaki Grupy NS



| Oznaczenie handlowe | A [mm] | B [mm] |
|---------------------|--------|--------|
| GT-NS7 | 113 | 36 |
| GT-NS10L | 113 | 36 |
| GT-NS20 | 129 | 45 |
| GT-NS30 | 170 | 56 |

► Obcinaki Grupy N

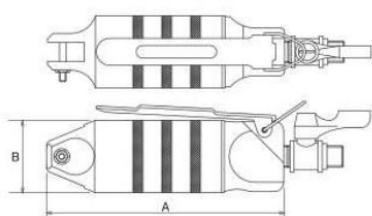

| Oznaczenie handlowe | A [mm] | B [mm] |
|---------------------|--------|--------|
| GT-N3 | 112 | 23 |
| GT-N5 | 103 | 30 |
| GT-N7 | 123 | 34 |
| GT-N10 | 132 | 34 |
| GT-N12 | 142 | 36 |
| GT-N20 | 156 | 45 |
| GT-N30 | 193 | 56 |
| GT-N50 | 237 | 75 |

► Obcinaki Grupy NR

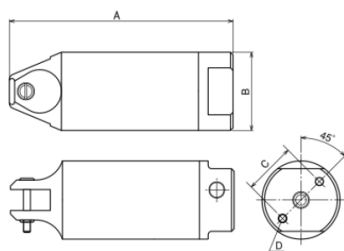

| Oznaczenie handlowe | A [mm] | B [mm] | C [mm] | D [mm] |
|---------------------|--------|--------|--------|--------|
| GT-NR05 | 94 | 30 | 20 | M4 |
| GT-NR10L | 113 | 36 | 24 | M4 |
| GT-NR20 | 129 | 45 | 30 | M5 |
| GT-NR30 | 165 | 56 | 40 | M6 |
| GT-NR50 | 222 | 75 | 50 | M8 |

► Noże do Obcinaków Grupy NS/N/NR



| Oznaczenie handlowe |
|---------------------|
| N3AP |
| N5AP |
| N7AP |
| N10AP |
| N15AP |
| N20AP |

| Oznaczenie handlowe |
|---------------------|
| N20AJ |
| N30AJ |

| Oznaczenie handlowe |
|---------------------|
| N7PF |
| N10LPF |
| N20PF |
| N30PF |

| Oznaczenie handlowe |
|---------------------|
| N50AS |

| Oznaczenie handlowe |
|---------------------|
| N50BBB |

► Obcinaki Grupy NT

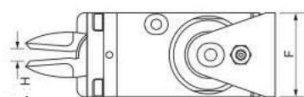

| Oznaczenie handlowe | A [mm] | B [mm] | C [mm] |
|---------------------|--------|--------|--------|
| GT-NT03 | 62 | 19 | 68,1 |
| GT-NT05 | 64 | 32 | 71,1 |
| GT-NT10 | 73 | 38 | 88,1 |
| GT-NT20 | 103 | 44 | 102,1 |

► Noże do Obcinaków Grupy NT



| Oznaczenie handlowe |
|---------------------|
| NT03AJ |
| NT05AJ |
| NT10AJ |
| NT20AJ |
| N15AP |
| N20AP |

| Oznaczenie handlowe |
|---------------------|
| NT05AJL |
| NT10AJL |
| NT20AJL |

| Oznaczenie handlowe |
|---------------------|
| NT03AJT |
| NT05AJT |
| NT10AJT |

► Obcinaki Grupy NK



| Oznaczenie handlowe | Długość [mm] | Szerokość [mm] | Wysokość [mm] | Nóż [mm] |
|---------------------|--------------|----------------|---------------|----------|
| GT-NK10 | 230,5 | 37 | 37 | NK10AJ |

► Obcinaki Grupy NKH



| Oznaczenie handlowe | Długość [mm] | Szerokość [mm] | Wysokość [mm] | Nóż [mm] |
|---------------------|--------------|----------------|---------------|----------|
| GT-NKH10 | 213,5 | 37 | 37 | NKH10AJ |

► Uchwyty do Obcinaków Grupy NR

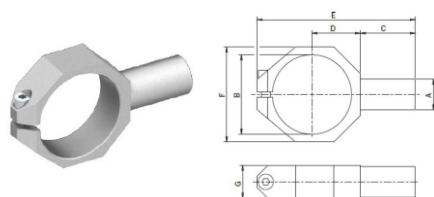

| Oznaczenie handlowe | A [mm] | B [mm] | C [mm] | D [mm] | E [mm] | F [mm] | G [mm] | Waga [g] |
|---------------------|--------|--------|--------|--------|--------|--------|--------|----------|
| GP.UNR.5 | 20 | 30 | 25 | 19 | 50 | 40 | 20 | 63 |
| GP.UNR.10 | 14 | 36 | 25 | 22 | 72 | 43 | 15 | 30 |
| GP.UNR.20 | 20 | 45 | 35 | 28 | 94,5 | 53 | 20 | 65 |
| GP.UNR.30 | 20 | 56 | 40 | 33 | 111 | 65 | 25 | 110 |
| GP.UNR.50 | 30 | 75 | 48 | 41 | 138 | 83 | 40 | 308 |

► Uchwyty do Obcinaków Grupy NS

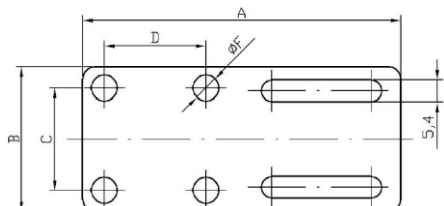

| Oznaczenie handlowe | A [mm] | B [mm] | C [mm] | D [mm] | F [mm] | Waga [g] |
|---------------------|--------|--------|--------|--------|--------|----------|
| GP.UNS.7 | 80 | 40 | 30 | 28 | 4,3 | 37 |
| GP.UNS.10 | 80 | 40 | 30 | 28 | 4,3 | 37 |
| GP.UNS.20 | 100 | 50 | 40 | 36 | 4,3 | 61 |
| GP.UNS.30 | 120 | 70 | 60 | 46 | 5,5 | 105 |

► Stand

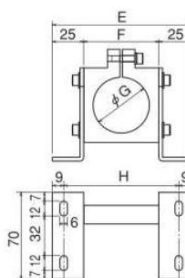
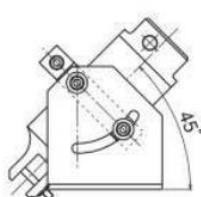

| Oznaczenie handlowe | E [mm] | F [mm] | G [mm] | H [mm] |
|---------------------|--------|--------|--------|--------|
| NR10LST | 102 | 52 | 36 | 84 |
| NR20ST | 110 | 60 | 45 | 92 |
| NR30ST | 130 | 80 | 56 | 112 |
| NR50ST | 150 | 100 | 75 | 132 |

7. Siłowniki Pneumatyczne

MGPM

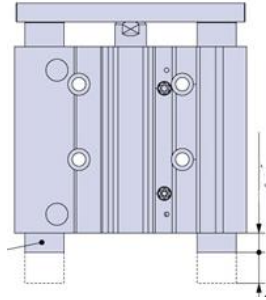

| Średn [mm] | Pręt [mm] |
|---------------|--------------|
| 12 | 6 |
| 16 | 8 |
| 20 | 10 |
| 25 | 12 |
| 32 | 16 |
| 40 | 16 |
| 50 | 20 |
| 63 | 20 |
| 80 | 25 |
| 100 | 30 |

C(D)QM

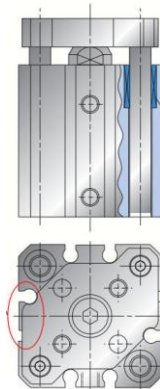

| Średn [mm] | Skok [mm] |
|---------------|--------------|
| 12 | 5-30 |
| 16 | 5-30 |
| 20 | 5-50 |
| 25 | 5-50 |
| 32 | 10-50 |
| 40 | 5-50 |
| 50 | 10-50 |
| 63 | 10-50 |
| 80 | 10-50 |
| 100 | 10-50 |

MHS3

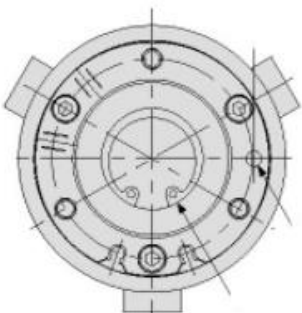

| Średn [mm] | Skok [mm] |
|---------------|--------------|
| 16 | 4 |
| 20 | 4 |
| 25 | 6 |
| 32 | 8 |
| 40 | 8 |
| 50 | 12 |
| 63 | 16 |
| 80 | 20 |
| 100 | 24 |
| 125 | 32 |

8. Pozostałe

8.1 Elementy Pneumatyczne

► Zawory dławiąco zwrotne

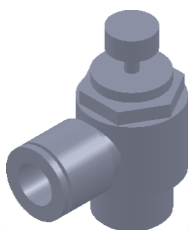

| Oznaczenie handlowe | Gwint | Średnica [mm] |
|---------------------|-------|---------------|
| GP.as.d1 | M5 | 4 |
| GP.as.d2 | M5 | 6 |
| GP.as.d3 | G1/8 | 4 |
| GP.as.d4 | G1/8 | 6 |

► Dławienie na wyjściu



| Oznaczenie handlowe | Gwint | Średnica [mm] |
|---------------------|-------|---------------|
| GP.as.d10 | M5 | 4 |
| GP.as.d11 | M5 | 6 |
| GP.as.d12 | G1/8 | 4 |
| GP.as.d13 | G1/8 | 6 |

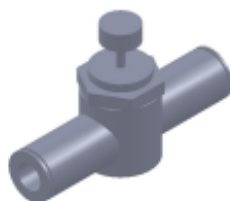

| Oznaczenie handlowe | Średnica [mm] | Średnica [mm] |
|---------------------|---------------|---------------|
| GP.rq-d30 | 4 | 4 |
| GP.rq-d31 | 6 | 6 |

► Dławienie na wejściu



| Oznaczenie handlowe | Gwint | Średnica [mm] |
|---------------------|-------|---------------|
| GP.as.d20 | M5 | 4 |
| GP.as.d21 | M5 | 6 |

► Przyłącza



| Oznaczenie handlowe | Gwint | Średnica [mm] |
|---------------------|-------|---------------|
| GP.kjh.p1 | M3 | 4 |
| GP.kjh.p2 | M5 | 4 |
| GP.kjh.p4 | G1/8 | 4 |
| GP.kjh.p5 | M5 | 6 |
| GP.kjh.p7 | G1/8 | 6 |



| Oznaczenie handlowe | Gwint | Średnica [mm] |
|---------------------|-------|---------------|
| GP.kjs.p20 | M3 | 4 |
| GP.kjs.p21 | M5 | 4 |
| GP.kjs.p23 | G1/8 | 4 |
| GP.kjs.p24 | M5 | 6 |
| GP.kjs.p25 | G1/8 | 6 |



| Oznaczenie handlowe | Średnica [mm] | Średnica [mm] |
|---------------------|---------------|---------------|
| GP.kjh.p10 | 4 | 4 |
| GP.kjh.p11 | 6 | 6 |
| GP.kjh.p12 | 4 | 6 |



| Oznaczenie handlowe | Średnica [mm] | Średnica [mm] |
|---------------------|---------------|---------------|
| GP.kjl.p40 | 4 | 4 |
| GP.kjl.p41 | 6 | 6 |
| GP.kjl.p42 | 4 | 6 |



| Oznaczenie handlowe | Gwint | Średnica [mm] |
|---------------------|-------|---------------|
| GP.kjl.p30 | M3 | 4 |
| GP.kjl.p31 | M5 | 4 |
| GP.kjl.p32 | G1/8 | 4 |
| GP.kjl.p33 | M5 | 6 |
| GP.kjl.p34 | G1/8 | 6 |

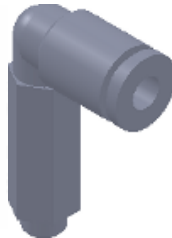

| Oznaczenie handlowe | Gwint | Średnica [mm] |
|---------------------|-------|---------------|
| GP.kjw.p130 | M5 | 4 |
| GP.kjw.p131 | G1/8 | 4 |
| GP.kjw.p132 | M5 | 6 |
| GP.kjw.p133 | G1/8 | 6 |

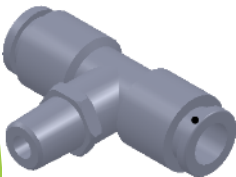

| Oznaczenie handlowe | Gwint | Średnica [mm] |
|---------------------|-------|---------------|
| GP.kjt.p50 | M5 | 4 |
| GP.kjt.p51 | G1/8 | 4 |
| GP.kjt.p52 | M5 | 6 |
| GP.kjt.p53 | G1/8 | 6 |



| Oznaczenie handlowe | Średnica [mm] | Średnica [mm] |
|---------------------|---------------|---------------|
| GP.kjt.p60 | 4 | 4 |
| GP.kjt.p61 | 6 | 6 |
| GP.kjt.p62 | 4 | 6 |

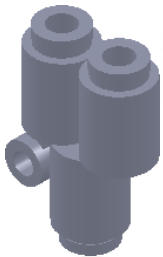

| Oznaczenie handlowe | Średnica [mm] | Średnica [mm] |
|---------------------|---------------|---------------|
| GP.kju.p70 | 4 | 4 |
| GP.kju.p71 | 6 | 6 |
| GP.kju.p72 | 4 | 6 |



| Oznaczenie handlowe | Gwint | Średnica [mm] |
|---------------------|-------|---------------|
| GP.kju.p80 | M5 | 4 |
| GP.kju.p81 | G1/8 | 4 |
| GP.kju.p82 | M5 | 6 |
| GP.kju.p83 | G1/8 | 6 |



| Oznaczenie handlowe | Średnica [mm] | Średnica [mm] |
|---------------------|---------------|---------------|
| GP.kje.p100 | 4 | 4 |
| GP.kje.p101 | 6 | 6 |



| Oznaczenie handlowe | Średnica [mm] | Średnica [mm] |
|---------------------|---------------|---------------|
| GP.kju.p90 | 4 | 4 |
| GP.kju.p91 | 6 | 6 |



| Oznaczenie handlowe | Gwint | Średnica [mm] |
|---------------------|-------|---------------|
| GP.kjy.p100 | M5 | 4 |
| GP.kjy.p101 | G1/8 | 4 |
| GP.kjy.p102 | M5 | 6 |
| GP.kjy.p103 | G1/8 | 6 |



| Oznaczenie handlowe | Gwint | Średnica [mm] |
|---------------------|-------|---------------|
| GP.kjf.p120 | M5 | 4 |
| GP.kjf.p121 | M5 | 6 |

8.2 Generatory Podciśnienia i Przewody



| Oznaczenie handlowe | Dysza [mm] | Wej [mm] | Wyj [mm] | Waga [g] |
|---------------------|------------|----------|----------|----------|
| GP.E.1 | 0,5 | 6 | 6 | 28 |
| GP.E.2 | 0,7 | 6 | 6 | 28 |
| GP.E.3 | 1 | 6 | 6 | 33 |
| GP.E.4 | 1,3 | 8 | 10 | 66 |



| Oznaczenie handlowe | Średnica [mm] | Grubość [mm] | Kolor |
|---------------------|---------------|--------------|-----------|
| GP.Pr.1(...) | 4 | 0,75 | A,B,C,E |
| GP.Pr.2(...) | 6 | 1 | A,B,C,E,G |
| GP.Pr.3(...) | 8 | 1,5 | A,B,C,E,G |

KOLORY:

A - Pomarańczowy

B - Niebieski

C - Przezroczysty

D - Żółty

E - Czarny

G - Czerwony

(...) - kolor

9. Czujniki

9.1 Czujniki Indukcyjne

GP.C.1

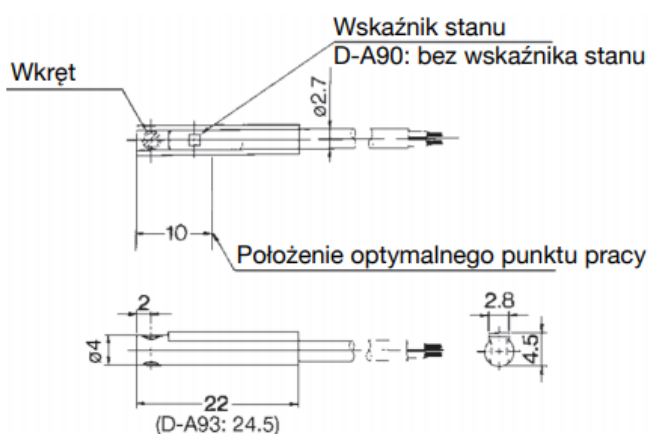

GP.C.2

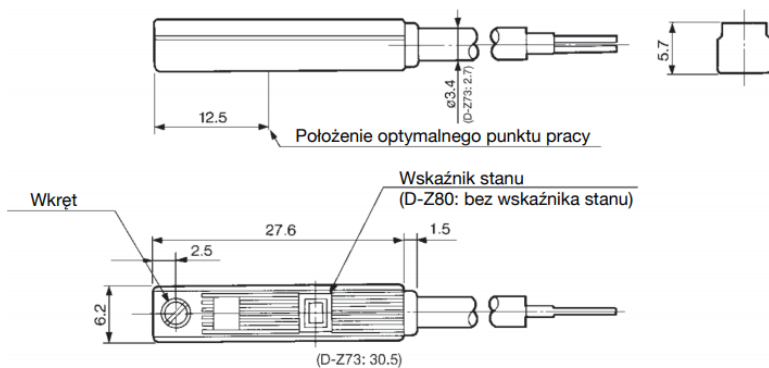

10. Akcesoria

10.1 Kleje

- ▶ WACKER SILICONES E43
- ▶ LOCTITE 406
- ▶ LOCTITE 4850



10.2 Okładziny

- ▶ VITON
- ▶ NBR
- ▶ HNBR





GRIPPER – POL

-

Ul. Gen. Kazimierza Pułaskiego 2
64-600 Oborniki

-

FAX: 61 842 87 95

-

www.gripper-pol.pl
biuro@gripper-pol.pl